

**PRO-Fit**<sup>™</sup> System

# Signature Series<sup>™</sup> Skimmer

**Installation Instructions & Owner's Manual**

- Step-by-Step Installation  
Instructions for the  
Signature Series<sup>™</sup> Skimmer



**PRO-Fit<sup>TM</sup> System**

# Signature Series<sup>TM</sup> Skimmer

## Installation Instructions & Owner's Manual

*Congratulations on the purchase of the AquascapePro<sup>TM</sup> Signature Series<sup>TM</sup> Skimmer.*

Thank you for choosing an Aquascape PRO-Fit<sup>TM</sup> System. Because we understand that your needs are different based on your preference, application or design, we want to give you the flexibility of using the different product lines that we offer within the same project without losing the ease of purchasing a kit.

Since the PRO-Fit<sup>TM</sup> System is designed to be used with different product lines, each PRO-Fit<sup>TM</sup> System will come with 2 sets of instructions: one for the skimmer (or MicroSnorkel<sup>TM</sup> and MicroCentipede<sup>TM</sup>) and one for the BIOFALLS<sup>®</sup> (or Endless Cascades<sup>TM</sup>). During the construction of the pond, you may have to refer to one or the other for the necessary steps.



## STEP 1

### Locate & Mark Out Your Pond Area

- We suggest that you use a plain old garden hose to define the shape of your new water feature. The hose is flexible, and can be pushed and pulled in various shapes. Step back, evaluate and modify your design until you have something that you really like.
- Double check to make sure the length and width of your layout does not exceed the amount of liner required for the pond.
- Be sure to locate the water garden close to a patio, deck, porch, or other hardscape. Also, keep in mind viewpoints of the water garden and waterfalls from inside. Try to make it visible from the kitchen, family room, or bedroom for year-round enjoyment.
- Once the water garden is shaped and defined with the hose, take a can of brightly colored, highly visible spray paint and outline the shape (around the hose) on the grass. (See fig. 1)



Fig. 1 Spray paint and outline the shape.

## STEP 2

### Place filters into position

- Since the BIOFALLS® filter is typically the main waterfall, it should be positioned so it's facing the main viewing areas.
- Make sure it is placed close to the edge of the pond so you can use the pond liner to connect up to the BIOFALLS® filter - unless you're adding a stream. Adding a stream will require the BIOFALLS® filter to be set further away from the pond and will require an extra section of stream liner.
- In order to maximize circulation, the BIOFALLS® filter and Skimmer are ideally placed on opposite ends of the pond, directly across from each other. (See fig. 2)

## STEP 3

### Lay plumbing

- To eliminate the need to dig a trench, lay the PVC flex pipe in place, along the edge of the pond, before excavation.
- The PVC flex pipe can withstand extreme weather conditions so it is unnecessary to dig a deep trench.
- To eliminate frozen and potentially broken PVC flex pipe, the pipe should be sloping down from the waterfall to the skimmer to help drain as much water from the line as possible.

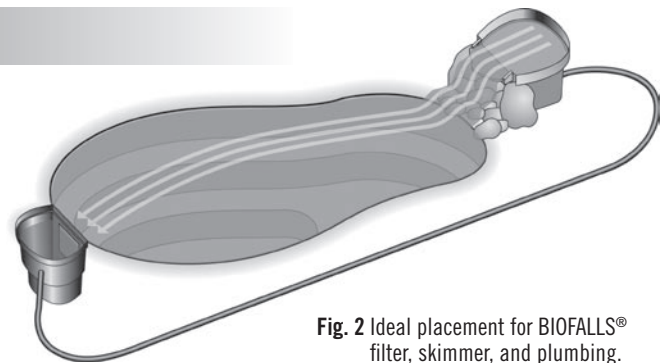

Fig. 2 Ideal placement for BIOFALLS® filter, skimmer, and plumbing.

At this point, please refer to the "Hook Up and Level BIOFALLS® Filter" step of your BIOFALLS®/ Endless Cascade Manual!

## STEP 4

### Excavate your Pond

#### The shape and depth

- We suggest excavating the pond no more than 18-24" deep. This depth provides the proper water levels required for aquatic plants and is deep enough to keep fish alive during winter.
- The excavation should be dug with a series of shelves. The shelves will add stability to the walls of the pond and will also create planting beds for different types of aquatic plants.
- The first shelf should be about 8-10" down (See fig. 3) or the height of a standard shovel.
- The second is typically down another 8-10" (See fig. 4).
- The third shelf (if desired) will be excavated down another 6" (See fig. 5), reaching a final excavation of 24".
- All of the soil removed from the excavation can be spread and compacted around the BIOFALLS® filter, creating a berm. The filter should be completely surrounded by soil by the end of the project.

## Excavate your Pond cont ...

### Design spaces for plants

- Design your shelves wider in areas where you wish to place aquatic plants. (See fig. 8)
- Marginal and bog plants require a water depth up to about 10", so the top shelf is a perfect location for these plants. (See fig. 8)
- Water lilies will vary according to species, but a depth of 12-24" at the crown works best, so the second shelf or bottom of the pond will work great for the lilies. (See fig. 8)
- To make planting lilies easier add a few 'lily pockets'. These pockets are simply depressions or bowls cut into the soil 6-8" deep and 10-16" in diameter. The goal is to create a natural looking pond, and this is possible only if plant pots are eliminated or completely hidden. (See fig. 8)
- It is typical to set the water level 2- 3" below the main viewing area (patio, deck, etc.). This will bring the water level of the pond up close to the edge of the pond without going over the sides. (See fig. 7)
- Dig a hole alongside the pond to house the skimmer filter. (See fig. 7)
- The skimmer should be excavated down to a depth so that the proposed water level in pond is approximately 2 1/2 to 3 inches below the top of the opening of the skimmer. Use the second screw insert down as a reference.
- The patent pending adjustable faceplate feature will allow you to fine tune your water level once the pond is full.
- Make sure the excavated shelf in front of the skimmer is low enough to provide access to the lower screws on the faceplate.
- Re-check all your measurements, including length and width of pond, plant shelf depth, and overall pond depth.

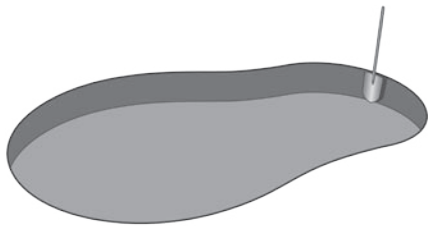

Fig. 3 Dig entire pond one shovel depth.

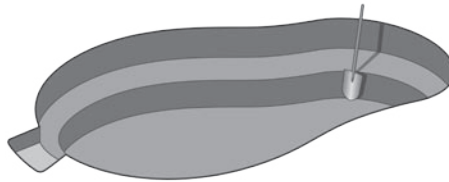

Fig. 4 Dig second shelf one shovel depth and start excavation of skimmer hole.

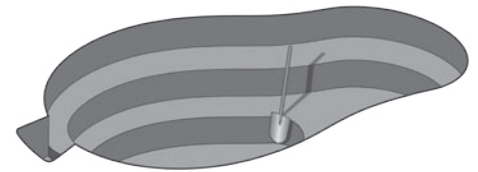

Fig. 5 Dig a third shelf, if desired.



Fig. 6 Dig the pond to its max depth and finish excavation of the skimmer hole.

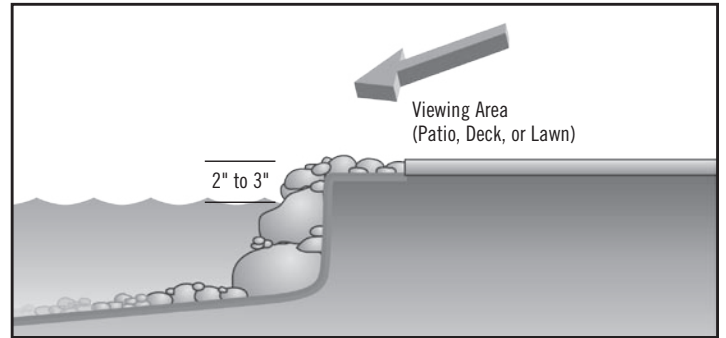

Fig. 7 Set water level 2" - 3" below viewing area.

### On the Level

When excavating, it is important to make sure that all of the edges are level. This is not only to avoid an unexpected low edge, but also to make sure that the skimmer sits at the proper height to skim. There are several different methods that can be used to level, depending on the resources that are available. The most accurate method is to use a transit, either sight or laser, and take several readings around

the perimeter. Transits need to be rented or bought, however, and may not be the most practical option for a one-time installation. There are two other options that utilize more common household items and may be more convenient. First, you can take a standard 2"x 4" board and lay it across the pond or basin with a common bubble level resting on the center. The level will show if the two sides are even, and all sides can be measured in the same way by altering the angle of the board across the

pond. The second method is to use a line level. A line level is basically a small bubble level attached to the end of a string. The other end of the string is then attached to a stake that is placed at any point around the perimeter. The level is then walked around and readings are taken at several different points to ensure the sides are even. Remember, the pond or basin does not have to be perfectly level, but general readings should be taken to avoid any major problems.



## Excavate your Pond cont ...

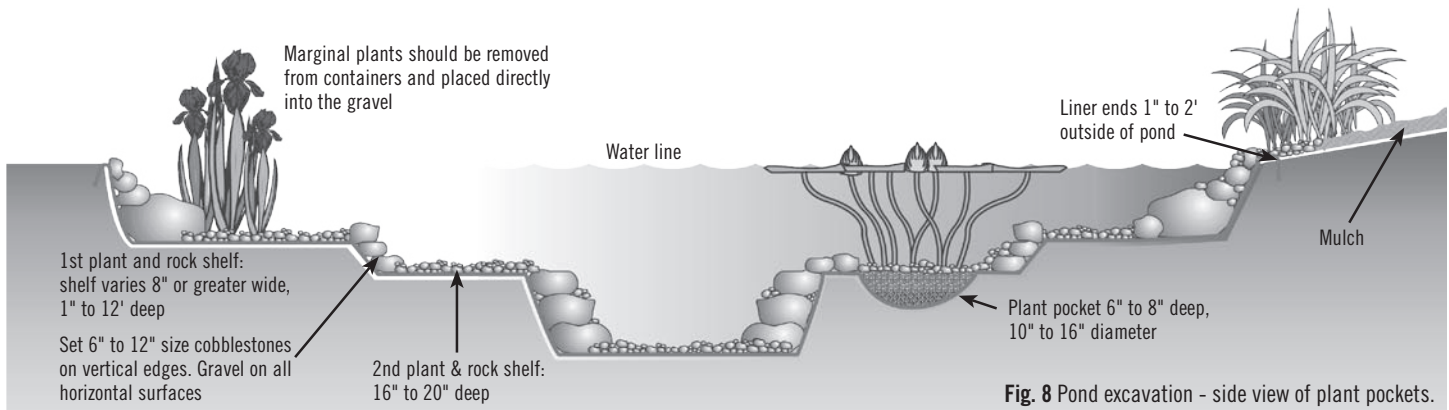

Fig. 8 Pond excavation - side view of plant pockets.

## STEP 5

### Install Underlayment and Liner

- Remove any sharp objects from the excavated hole that may damage the liner.
- Unfold the underlayment fabric and place it into your excavated pond. Starting from the bottom, remove the slack from the underlayment, making sure it conforms into all of the elevations.
- Place the EPDM Fish-Safe liner on top of the underlayment. (See fig. 9)
- The installation process is the same as the underlayment, starting at the bottom and contouring the liner up and out of the pond.
- Try to get the large folds out, but the main goal is to make sure that it's lying flat and going into all corners. Don't try to get it perfect—you will hide the liner with rocks and gravel later.
- Make sure the liner is high enough around the edges of the pond. This should not be a problem if you measured out the pond and excavated it correctly. Problems can be fixed by readjusting the liner into the excavation, backfilling (making the pond smaller) in areas where there is not enough liner, or simply buying a larger liner.

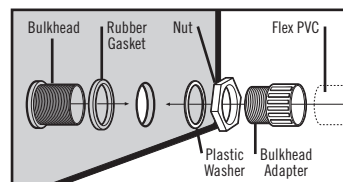

Fig. 9 Place the liner on top of the underlayment following the same installation procedures. Make sure liner is positioned in such a way that allows it to extend and completely cover the opening on the BIOFALLS® filter.

## STEP 6

### Installing the Skimmer and Overflow Installation

- Install the two bulkheads into the back of the Signature Series™ Skimmer prior to dropping into the excavated hole. The filter has two openings on the back allowing several plumbing options.
1. For single pump applications, the pump plumbing line attaches into one bulkhead and the overflow is attached to the other. Use the angle of the bulkheads to your advantage by choosing the bulkhead that works best with the direction and sweep of the plumbing to the BIOFALLS® filter. (See fig. 10)
  2. For double pump applications, each pump will hook up to one of the bulkheads. A 3rd hole will need to be drilled in the back of the skimmer if you desire to add an overflow. A drill point guide can be found on the head of the frog within the logo. Use a 3 inch hole saw to drill the opening for another bulkhead fitting (sold separately). (See fig. 11)
- Follow the same bulkhead installation steps used when installing the bulkhead on the BIOFALLS® filter. (see bulkhead assembly).
  - Install the PVC slip fitting into each bulkhead on the outside of the skimmer to receive the pump plumbing and overflow plumbing.



Bulkhead assembly.



Fig. 10 Single pump and overflow.

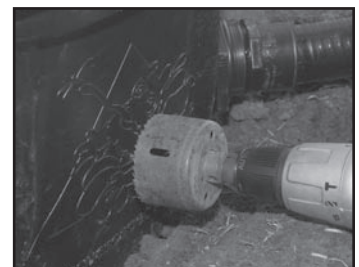

Fig. 11 Double pumps require a third hole for overflow assembly.

## Installing the Skimmer and Overflow Installation cont ...

- Use some of the silicone sealant or teflon tape (not included) to coat the threads of the fitting, in order to help provide a watertight seal.

### Set up and Level the Skimmer

- You've already roughed out a hole for the skimmer during the excavation phase. Use a 2' bubble level in order to make sure your Skimmer is properly set into position. Your Skimmer should be level from side-to-side and front to back.
- Once level, glue the flexible PVC pipe from the BIOFALLS® filter into the desired fitting. Follow the same priming and gluing steps used when installing the PVC Flex into the BIOFALLS® filter (see BIOFALLS® manual).
- Follow instructions for Overflow Installation.

### Attaching the Skimmer Liner Plate

- Position the liner against the Skimmer opening, making sure there is slack below the opening. This will help reduce tension on the liner plate when placing boulders in front of the unit.
- Mark the outer perimeter of the Skimmer opening on the liner; then mark a second box 1.5" inside of it. This ensures that you don't cut too much of the liner, which would result in a possible leak. (See fig. 13)
- Cut the inner box using a pair of scissors, and insert the skimmer liner plate into the hole.
- Temporarily install the liner plate and liner to the skimmer using two screws in the upper corners. Using an awl or nail, poke the first hole in the liner. Be careful not to damage the threads on the nut inserts when punching the holes with the awl! Remove the awl or nail while holding the liner plate and liner in place and begin threading one of the screws into the filter. Repeat this process for the other screw. (See fig. 14)
- Note:** Power tools are not recommended for installing the screws and may strip the nut inserts.
- Now remove the liner plate from the skimmer, keeping the screws installed through the liner plate and liner.
- Pre-installing the two screws in the earlier steps will make it easy to line up the skimmer faceplate after the silicone is applied and will keep the silicone in as thick of a bead as possible. Apply a bead of fish-safe silicone sealant around the skimmer opening, over the nut inserts. (See fig. 15)
- Replace the skimmer liner plate and the two corner screws, and then proceed with the bottom two corners (See fig. 16). Make sure the holes in the liner plate that the weir flap clicks into are on the bottom.
- With the 4 corners secured, you may now punch the remaining holes with your awl and thread in

all the screws. Again, be careful not to damage the threads on the nut inserts.

- Let dry for at least one hour before introducing water!

**Note:** Pump and debris basket assembly instructions are found in Step 9.

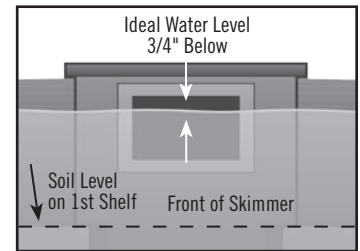

Fig. 12 Cross section of ideal water level viewed from front of skimmer.

### Overflow Installation

- The built in overflow will allow the water in an overflow situation to flow through the pipe and drain away from the pond. Use a pvc plug (not included) to plug the bulkhead if you do not want the overflow option.
- Excavate a trench for a section of PVC Flex pipe to come off the back of the desired bulkhead. The trench should be no less than 5 ft from the back of the skimmer and be graded away from the pond (See fig. 17).
- Create a drainage area at the end of the pipe by excavating a small pit, roughly 16 inches in diameter and at least 12 inches deep. Fill the pit with excess gravel

- Prime and glue the section of PVC Flex pipe into the bulkhead and run it to the top of the gravel pit. Cover the gravel pit with a small section of underlayment and top with soil.

**Note:** Install the "dial-in" overflow adjustment arm into the corresponding bulkhead on the inside of the skimmer. Use silicon or Teflon tape (not included) on the threads prior to installing the fitting. Tighten the fitting in the bulkhead as far as possible with the overflow arm in the highest position. The final overflow adjustment can be made once the final water level is set using the adjustable skimmer liner plate. See section on setting the adjustable liner plate and overflow (page 10).

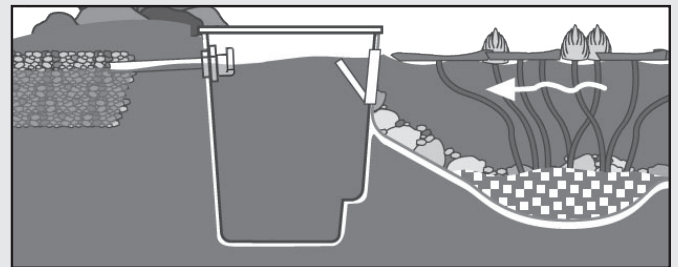

Fig. 17 Overflow diagram.



Fig. 13 Mark the outer perimeter of the skimmer opening on the liner; then mark a second box 1.5" inside mark. Cut out at inside mark.



Fig. 14 Remove the awl or nail while holding the liner plate and liner in place and begin threading one of the screws into the filter.



Fig. 15 Apply a bead of fish-safe silicone sealant around the skimmer opening, over the nut inserts.



Fig. 16 Replace the skimmer liner plate and the two corner screws, and then proceed with the bottom two corners. Punch remaining holes, thread screws.

## STEP 7

### Add Rock and Gravel

- You can expect to use several tons of stone and gravel for your water feature. Talk to your dealer for help choosing the quantity and sizes of stone and gravel.

#### Rocking in the Pond

- Start from the bottom and set the largest character boulders first against the vertical walls; then stack the smaller boulders on top. (See fig. 18)
- Be careful when placing any large boulders so you don't damage the liner.
- The opening on the front of the skimmer can be hidden by placing boulders on either side and bridging a stone across, creating a cave effect.

**Note:** Make sure the boulders do not block the water flow into the skimmer.

- Cover all remaining flat surfaces with a couple inches of decorative gravel. This will help lock the boulders in place, as well as cover the remaining liner, protecting it

from ultraviolet rays, and giving bacteria a place to colonize, not to mention it just looks better.

- This is also a good time to add lilies to the plant pockets. Remove the lily from the pot and place it into the lily pocket. Top-dress the lily with a layer of gravel to hold the soil into place. Lilies, if not on hand at this time, can be added after the pond is filled. (See fig. 19)

#### Underwater Lights

- After the boulders are in position, set your underwater lights in between your boulders so they are hidden from view. For the greatest effect, lights should face away from the main viewing area. (See fig. 20)
- See lighting system instructions for placement, positioning, and installation of underwater lights.
- 10-watt waterfall lights can be installed in the stream and waterfall later in the project.



**Fig. 18** Starting at the bottom, set the largest character boulders first then fill in with the smaller ones.



**Fig. 19** Loose gravel should be placed around the lily to keep the soil from being stirred up in the pond after the water is added.

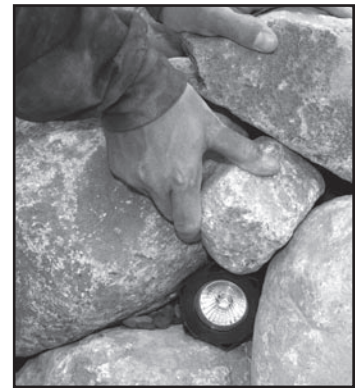

**Fig. 20** Set your underwater lights in between your boulders so they are hidden from view.

## STEP 8

### Wash Rocks and Gravel

- Using a garden hose, rinse the rocks and gravel from the highest part of the pond down to the bottom.
- Place an AquascapePro clean-out pump or the pump purchased with the pond kit in the lowest

area of the pond. Use discharge hose or an extra section of PVC Flex pipe to pump the muddy water. This step helps the pond clear up faster.



## STEP 9

### Installing the Pump, Filter Rack and Filter Mat

- The Signature Series™ check valve comes with two adaptors that replace the standard PVC pipe sockets on each end of the check valve (See Fig. 21). One adaptor threads directly into the pump, the other threads directly into the bulkhead on the back of the skimmer that supplies water to the BIOFALLS® filter. Apply silicone or Teflon tape (not included) to the threads of the fitting (See Fig. 23 & 24).
- The 2nd hole located in the back of the skimmer is for the overflow. The overflow will help maintain the maximum water level in the pond after rainfall, ensuring that your skimmer works properly and water does not travel over the edges of the liner and cause problems with hydrostatic pressure. Refer back to page 6 for overflow information.
- Once inside the skimmer, feed the electrical cord over the depression located on the back, top edge of the skimmer. (See fig. 25)
- Set the Filter Rack inside the skimmer. (See fig. 26) Punch out the corresponding die-cut hole located on the skimmer filter mat and insert the skimmer mat into the filter. (See fig. 27)
- If using Tsurumi or AquaSurge™ pump, please refer to check valve assembly instructions for further information.

#### Assembly of the Adjustable Faceplate in the Skimmer Basket

- The weir plate (See fig. 28) fits onto the slide plate and is attached with 2 large thumb screws into the corresponding threaded inserts.
- The slide assembly can now be placed inside the basket and attached with the 6 small stainless screws threaded in from outside face of the basket. (See fig. 29 & 30)

- Place the basket in the skimmer. (See fig. 31) The basket fits into the front edge of the filter support rack. Please note that the support rack is what supports the basket. The tabs on the top edge of the basket are not load bearing and simply hold the basket up to the face of the skimmer.

#### Assembly of the Adjustable Faceplate

- The patent pending adjustable faceplate allows the final water level of the pond to be adjusted. Please note that this feature is for making final adjustments and tweaks to the water level. It is important the skimmer was set to the proper water level to begin with. You may find you'll need to reset the entire skimmer box if making minor adjustments when the adjustable liner plate does not meet the desired water level.
- Make sure the pond is filled to the desired level prior to making final adjustments.
- Adjust the weir opening to the appropriate water level by loosening the thumbscrews and adjusting as needed. (See fig. 32) There should be approximately 3/4 inch gap between the water level and the top of the faceplate opening to allow proper skimmer action.

- Dial-in the adjustable overflow arm so that water rising past the desired level will begin to trickle down the overflow arm. (See fig. 33) Please note that we recommend to re-silicone or Teflon tape (not included) the threads of the overflow fitting once the final position is determined. Once the overflow is set, the pond owner should not readjust. Readjustment may require the threads to be re-siliconed or Teflon taped to prevent water loss.

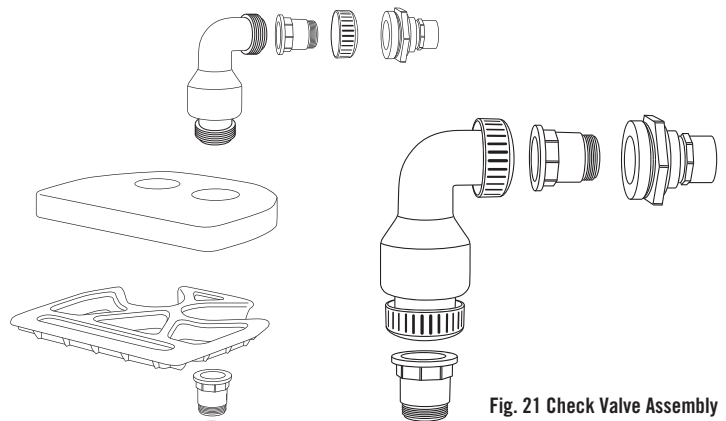

Fig. 21 Check Valve Assembly

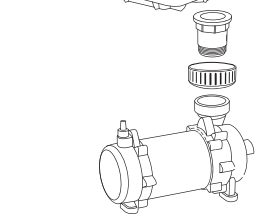

Fig. 22 Pump Assembly



Fig. 23 One adaptor threads directly into the pump, the other threads directly into the bulkhead on the back of the skimmer.



Fig. 24 Apply silicone or Teflon tape (not included) to the threads of the fitting.  
**NOTE:** One pump shown. Your installation may have two pumps.

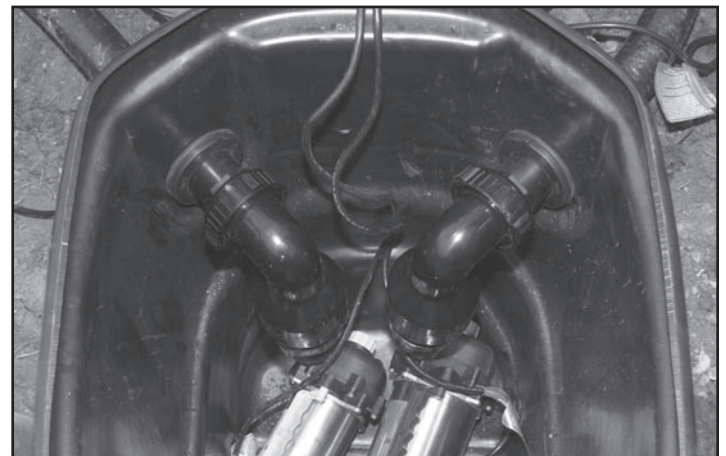

Fig. 25 Feed the electrical cord over the depression.



## Installing the Pump, Filter Rack and Mat cont ...

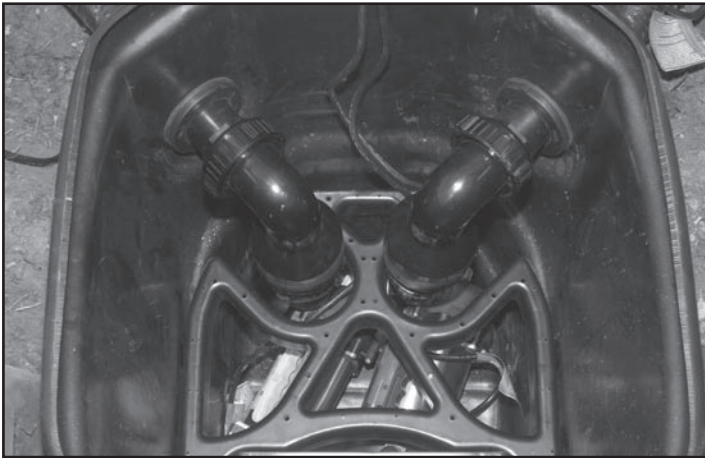

Fig. 26



Fig. 27

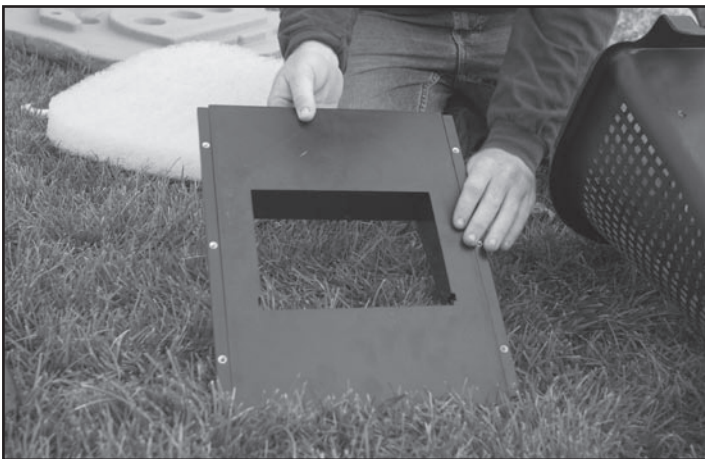

Fig. 28 The weir plate is attached with 2 large thumb screws into the corresponding threaded inserts.



Fig. 29 Place the slide assembly inside the basket.



Fig. 30 Use 6 small stainless screws threaded in from outside face of the basket to attach the slide assembly.

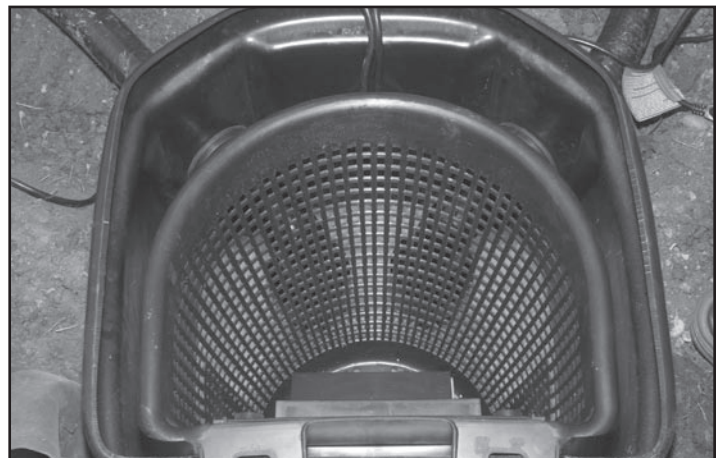

Fig. 31 Place the basket in the skimmer.

**Installing the Pump, Filter Rack and Filter Mat cont ...**



**Fig. 32** Adjust the weir opening to the appropriate water level by loosening the thumbscrews.



**Fig. 33** Dial-in the adjustable overflow arm.

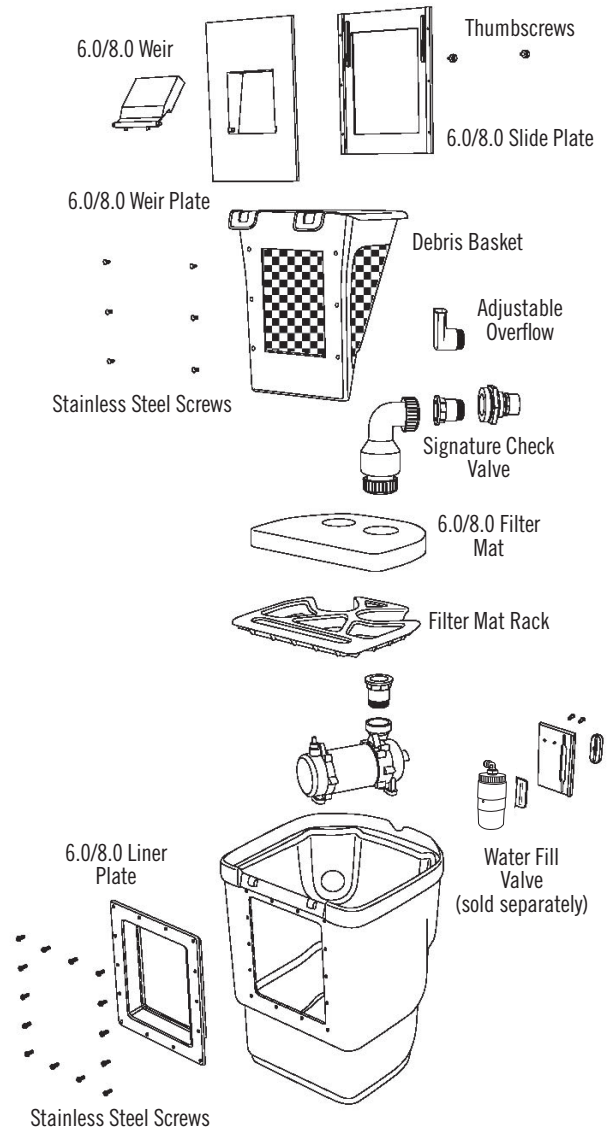

**STEP 10**

**Fill Pond**

Fill up the pond with water, just below the level of the overflow in the skimmer.



## Signature Series™ Stone Lid

- The Signature Series™ stone has several channels molded in the top to allow mulch or gravel to be added to help camouflage.
- The stone lid fits on in one direction. Look at the underside of the stone to determine the proper interface with the shape of the

skimmer basket. (See fig. 34) This tight fit is designed to help keep frogs from jumping over the side of the basket.

- You can cover the lid with rocks, mulch, or whatever landscaping material you have surrounding your skimmer. (See fig. 35)



**Fig. 34** Look at the underside of the stone to determine the proper interface with the shape of the skimmer basket.



**Fig. 35** You can cover the lid with rocks, mulch or other landscape material.

## General Maintenance & Seasonal Care

### Debris Basket

The Signature Series™ Skimmer is designed to sweep the surface of the water so this it is free from debris. The debris basket inside the skimmer is the first filter stage of the skimmer. The basket will collect leaves, twigs, seeds, and other pond debris. It takes approximately two to three minutes every other week to

empty the debris net. More frequent changes will be required during the fall and spring because of the quantity of leaves falling off the surrounding trees.

It is a good habit during your first season with the pond to periodically lift the skimmer lid and check the quantity of debris in the basket. This is especially true in the fall.

Keep a mental note as to how often your basket has to be emptied. It's important that the debris basket is not allowed to become too full- too much debris can reduce the water flow to the pump.

### Filter Mat

The filter mat below the debris basket is the second stage of the

skimmer. The mat is designed to handle any debris that finds its way past the basket. The mat will not need maintenance as frequently as the basket, since the basket will remove the majority of debris from the water. Remove and rinse the mat when you notice less flow over the waterfall.

## More great products by Aquascape:

### EcoSystems® EcoBlast™

EcoBlast™ is the latest in our water treatment arsenal. EcoBlast™ is the first line of defense to quickly and safely break down algae from waterfalls, streams, rocks, plant pots and anywhere algae build-up has occurred. Start using EcoBlast™ to spot treat the trouble areas on the pond and follow up with S.A.B.™ Extreme on a monthly basis to help keep it clear!

#### Fast Acting!

EcoBlast™ is not temperature sensitive and can be used during colder temperatures. 100% safe for fish.

*EcoBlast™ applications are based on sq.ft. of affected areas:*

8.8 oz. treats up to 200 square feet.  
38.4 Oz. treats up to 780 square feet.  
7 lb. treats up to 2,275 square feet.



### EcoSystems® S.A.B. Extreme

Includes  
**Activated Barley®**

S.A.B.™ Extreme is designed to restore balance to the pond ecosystem by breaking down organic material that creates problems for pond hobbyists in and around waterfalls, rocks, stream beds, plant pots, pumps and filtration systems.

S.A.B.™ Extreme is actually 3 products in 1! We have taken the natural ingredients that make up S.A.B.™ and combined them with the degrading powers of Activated Barley™ and the natural biological filtering powers of AquaClearer™ Extreme Dry Bacteria

- Helps break down organic materials that create debris problems around waterfalls, rocks, plant pots, pumps and filtration systems
- Fortified with AquaClearer™ Extreme Dry Bacteria & Enzymes
- Works great in combination with EcoBlast™

8.8 oz. treats up to 2,700 gallons  
38.4 oz. treats up to 12,000 gallons  
7 lb. treats up to 33,800 gallons



### EcoSystems® EcoFloc™

EcoFloc™ clears pond water by combining suspended particulate via a process commonly known as flocculation. Combined particulates are easily removed. It is a 100% safe and natural product, will not harm fish, plants, or wildlife.

8 oz. liquid treats up to 4,000 gallons  
23 oz. liquid treats up to 11,500 gallons



### EcoSystems® EcoBarley™

EcoBarley™ is an easy to use quick acting pellet. It can be used inside most filters and skimmer systems, as well as set off to the side of the pond. Includes mesh bag for easy application. Tap into the natural degrading power of barley to help create a clear, unfouled pond.

2 lb. box treats up to 3,000 gallons  
5 lb. tub treats up to 7,500 gallons



### EcoSystems® EcoCarbon™

EcoCarbon™ safely clears tea-colored pond water. EcoCarbon™ is highly effective at removing dissolved organics from the pond water, such as stains and discoloration caused by leaves and organic debris. EcoCarbon™ is also an effective method to remove trace amounts of chlorine and chloramines.

4 lb. treats up to 800 gallons  
9 lb. treats up to 1,800 gallons  
18 lbs. treats up to 3,600 gallons

**Removes  
Odor!**



For more information on care and maintenance, please refer to Aquascape's *Ecosystem Pond* or *Pond Building for Hobbyists* books or visit [www.aquascapeinc.com](http://www.aquascapeinc.com)